

A3 package: 750V 600A IGBT module

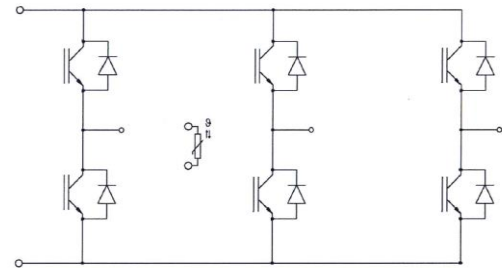
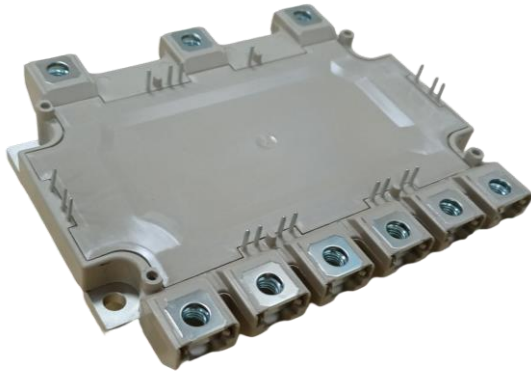

等效电路图

Equivalent Circuit Schematic

Features:

- 750V 600A, $V_{CE(sat)} = 1.4V @ 25^{\circ}C$
- High RBSOA capability
- Micro pattern trench/FS technology
- Low switching losses
- High SC capability
- Direct Cooled Base Plate with PinFin

Typical Applications:

- Automotive Applications
- Motor Drives
- Inverters

产品特性:

- 750V 600A, $V_{CE(sat)} = 1.4V @ 25^{\circ}C$
- 高 RBSOA 能力
- 微沟槽/场终止技术
- 低开关损耗
- 高短路能力
- 直接冷却 PinFin 基板

典型应用:

- 汽车应用
- 电机驱动
- 逆变器

IGBT, Inverter / IGBT, 逆变部分

Maximum Rated Values / 最大标称参数

Collector-emitter voltage 集电极-发射极电压	$T_{vj}=25^{\circ}\text{C}$	V_{CES}	750	V
Continuous DC collector current 集电极连续直流电流		$I_{C\text{ nom}}$	600	A
	$T_C=65^{\circ}\text{C}, T_{vj\text{ max}}=175^{\circ}\text{C}$	I_C	670	A
Repetitive peak collector current 集电极可重复峰值电流	$t_p=1\text{ms}$	I_{CRM}	1200	A
Total power dissipation 功率损耗	$T_C=25^{\circ}\text{C}, T_{vj\text{ max}}=175^{\circ}\text{C}$	P_{tot}	1456	W
Gate-emitter peak voltage 门极-发射极峰值电压		V_{GES}	± 20	V

Characteristic Values / 性能参数

min. typ. max.

				min.	typ.	max.	
Collector-emitter saturation voltage 集电极-发射极饱和电压	$I_C=600\text{A}, V_{GE}=15\text{V}$ $I_C=600\text{A}, V_{GE}=15\text{V}$	$T_{vj}=25^{\circ}\text{C}$ $T_{vj}=150^{\circ}\text{C}$	V_{CESat}	-	1.40 1.60		V
Gate threshold voltage 门极阈值电压	$V_{CE}=V_{GE}, I_C=8\text{mA}$	$T_{vj}=25^{\circ}\text{C}$	V_{GEth}	5.00	6.00	7.00	V
Internal gate resistor 内置门极电阻		$T_{vj}=25^{\circ}\text{C}$	R_{Gint}	-	0.70	-	Ω
Input capacitance 输入电容	$V_{CE}=25\text{V}, V_{GE}=0\text{V}, f=100\text{kHz}$	$T_{vj}=25^{\circ}\text{C}$	C_{ies}	-	TBD	-	nF
Reverse transfer capacitance 反向传输电容	$V_{CE}=25\text{V}, V_{GE}=0\text{V}, f=100\text{kHz}$	$T_{vj}=25^{\circ}\text{C}$	C_{res}	-	TBD	-	nF
Gate charge 门极电荷	$V_{GE}=\pm 15\text{V}$		Q_G	-	TBD	-	μC
Collector-emitter cut-off current 集电极-发射极关断漏电流	$V_{CE}=750\text{V}, V_{GE}=0\text{V}$	$T_{vj}=25^{\circ}\text{C}$	I_{CES}	-	-	1.0	mA
Gate-emitter leakage current 门极-发射极漏电流	$V_{CE}=0\text{V}, V_{GE}=20\text{V}$	$T_{vj}=25^{\circ}\text{C}$	I_{GES}	-	-	500	nA
Turn-on delay time, inductive load 开通延迟时间, 感性负载	$I_C=600\text{A}, V_{CE}=400\text{V}$ $V_{GE}=-8\text{V}/15\text{V}$ $R_{Gon}=2.0\Omega$	$T_{vj}=25^{\circ}\text{C}$	t_{don}	-	150	-	ns
		$T_{vj}=125^{\circ}\text{C}$			172		
		$T_{vj}=150^{\circ}\text{C}$			189		
Rise time, inductive load 上升时间, 感性负载	$I_C=600\text{A}, V_{CE}=400\text{V}$ $V_{GE}=-8\text{V}/15\text{V}$ $R_{Gon}=2.0\Omega$	$T_{vj}=25^{\circ}\text{C}$	t_r	-	90	-	ns
		$T_{vj}=125^{\circ}\text{C}$			104		
		$T_{vj}=150^{\circ}\text{C}$			108		
Turn-off delay time, inductive load 关断延迟时间, 感性负载	$I_C=600\text{A}, V_{CE}=400\text{V}$ $V_{GE}=-8\text{V}/15\text{V}$ $R_{Goff}=12\Omega$	$T_{vj}=25^{\circ}\text{C}$	t_{doff}	-	988	-	ns
		$T_{vj}=125^{\circ}\text{C}$			1042		
		$T_{vj}=150^{\circ}\text{C}$			1060		
Fall time, inductive load 下降时间, 感性负载	$I_C=600\text{A}, V_{CE}=400\text{V}$ $V_{GE}=-8\text{V}/15\text{V}$ $R_{Goff}=12\Omega$	$T_{vj}=25^{\circ}\text{C}$	t_f	-	117	-	ns
		$T_{vj}=125^{\circ}\text{C}$			112		
		$T_{vj}=150^{\circ}\text{C}$			114		
Turn-on energy loss per pulse 开通损耗	$I_C=600\text{A}, V_{CE}=400\text{V}$ $V_{GE}=-8\text{V}/15\text{V}$ $R_{Gon}=2.0\Omega$	$T_{vj}=25^{\circ}\text{C}$	E_{on}	-	22.4	-	mJ
		$T_{vj}=125^{\circ}\text{C}$			28.4		
		$T_{vj}=150^{\circ}\text{C}$			32.9		
Turn-off energy loss per pulse 关断损耗	$I_C=600\text{A}, V_{CE}=400\text{V}$ $V_{GE}=-8\text{V}/15\text{V}$ $R_{Goff}=12\Omega$	$T_{vj}=25^{\circ}\text{C}$	E_{off}	-	51.7	-	mJ
		$T_{vj}=125^{\circ}\text{C}$			56.0		
		$T_{vj}=150^{\circ}\text{C}$			58.0		
SC data 短路耐受	$V_{CC}=400\text{V}, V_{GE}=-8\text{V}/15\text{V},$ $V_{CE\text{ max}}=V_{CES}-L_S\text{E}\cdot di/dt$	$T_{vj}=150^{\circ}\text{C}$	t_{psc}	6	-	-	μs

Thermal resistance, junction to cooling fluid 结-散热器热阻	Per IGBT/单个 IGBT	R_{thJF}	-	0.103	-	kW
Temperature under switching conditions 工作温度	t_{op} continuous	$T_{vj op}$	-40	-	150	°C

Diode, Inverter / 二极管, 逆变部分

Maximum Rated Values / 最大标称参数

Repetitive peak reverse voltage 可重复反向峰值电压	$T_{vj}=25^{\circ}\text{C}$	V_{RRM}		750		V
Continuous DC forward current 可连续正向直流电流		I_{Fnom}		600		A
Repetitive peak forward current 可重复正向峰值电流	$I_{FRM}=2 \times I_F$	I_{FRM}		1200		A

Characteristic Values / 性能参数

			min.	typ.	max.		
Forward voltage ¹⁾ 正向通态压降	$I_F=600\text{A}, V_{GE}=0\text{V}$	$T_{vj}=25^{\circ}\text{C}$ $T_{vj}=150^{\circ}\text{C}$	V_F	-	1.50 1.42	-	V
Reverse recovery time 反向恢复时间	$I_F=600\text{A}, V_R=400\text{V}$ $di_F/dt=3968\text{A}/\mu\text{s}(T_{vj}=150^{\circ}\text{C})$ $V_{GE}=-8\text{V}$	$T_{vj}=25^{\circ}\text{C}$ $T_{vj}=125^{\circ}\text{C}$ $T_{vj}=150^{\circ}\text{C}$	t_{rr}	-	148 217 319	-	ns
Peak reverse recovery current 反向恢复峰值电流	$I_F=600\text{A}, V_R=400\text{V}$ $di_F/dt=3968\text{A}/\mu\text{s}(T_{vj}=150^{\circ}\text{C})$ $V_{GE}=-8\text{V}$	$T_{vj}=25^{\circ}\text{C}$ $T_{vj}=125^{\circ}\text{C}$ $T_{vj}=150^{\circ}\text{C}$	I_{RM}	-	232 272 280	-	A
Recovery charge 反向恢复电荷	$I_F=600\text{A}, V_R=400\text{V}$ $di_F/dt=3968\text{A}/\mu\text{s}(T_{vj}=150^{\circ}\text{C})$ $V_{GE}=-8\text{V}$	$T_{vj}=25^{\circ}\text{C}$ $T_{vj}=125^{\circ}\text{C}$ $T_{vj}=150^{\circ}\text{C}$	Q_R	-	17.5 29.8 34.9	-	μC
Reverse recovery energy 反向恢复损耗	$I_F=600\text{A}, V_R=400\text{V}$ $di_F/dt=3968\text{A}/\mu\text{s}(T_{vj}=150^{\circ}\text{C})$ $V_{GE}=-8\text{V}$	$T_{vj}=25^{\circ}\text{C}$ $T_{vj}=125^{\circ}\text{C}$ $T_{vj}=150^{\circ}\text{C}$	E_{rec}	-	4.4 7.5 8.8	-	mJ
Thermal resistance, junction to cooling fluid 结-散热器热阻	Per FRD/单个 FRD		R_{thJF}	-	0.165	-	kW
Temperature under switching conditions 工作温度	t_{op} continuous		$T_{vj op}$	-40	-	150	°C

NTC-Thermistor/ NTC-热敏电阻

Characteristic Values / 性能参数

			min.	typ.	max.	
Rated resistance 标称电阻	$T_{NTC}=25^{\circ}\text{C}$	R_{25}	-	5	-	K Ω
Deviation of R100 R100 偏移值	$T_{NTC}=100^{\circ}\text{C}, R_{100}=493.3\Omega$	$\Delta R/R$	-5	-	5	%
Power dissipation 功率耗散	$T_{NTC}=25^{\circ}\text{C}$	P_{25}	-	-	20	mW
B-value B 值	$R_2=R_{25} \exp[B_{25/50}(1/T_2-1/(298.15\text{K}))]$	$B_{25/50}$	-	3375	-	K
	$R_2=R_{25} \exp[B_{25/80}(1/T_2-1/(298.15\text{K}))]$	$B_{25/80}$	-	3414	-	K
	$R_2=R_{25} \exp[B_{25/100}(1/T_2-1/(298.15\text{K}))]$	$B_{25/100}$	-	3436	-	K

Module / 模块

Isolation test voltage 绝缘测试电压	RMS, f=50Hz, t=1min	V_{ISOL}	3		KV	
Material of module baseplate 模块底板材料			Cu			
Internal isolation 内部绝缘			Si_3N_4			
Creepage distance 爬电距离	Terminal to heatsink Terminal to terminal		12.0 6.1		mm	
Clearance 电气间隙	Terminal to heatsink Terminal to terminal		12.0 6.1		mm	
Comparative tracking index 相对漏电起痕指数		CTI	200 ²⁾			
			min.	typ.	max.	
Stray inductance module 模块杂散电感		L_{SCE}	-	15	-	nH
Module lead resistance, terminals- chip 模块引脚电阻, 端子-芯片	$T_c=25^\circ C$, Per Switch	$R_{CC'+EE'}$	-	1.0	-	m Ω
Storage temperature 贮存温度		T_{stg}	-40	-	125	$^\circ C$
Mounting torque for module mounting 模块安装力矩	Screw M5 / M5 螺丝 Baseplate to heatsink	M	3.0	-	6.0	Nm
Terminal connection torque 功率端子连接力矩	Screw M6 / M6 螺丝	M	3.0	-	6.0	Nm
Weight 重量		G	-	685	-	g

- 1) Terminal impedance is not included.
不包含端子阻抗。
- 2) CTI is about 200.
CTI 约等于 200。

Package Dimension / 封装尺寸

Dimensions in Millimeters / 毫米为单位

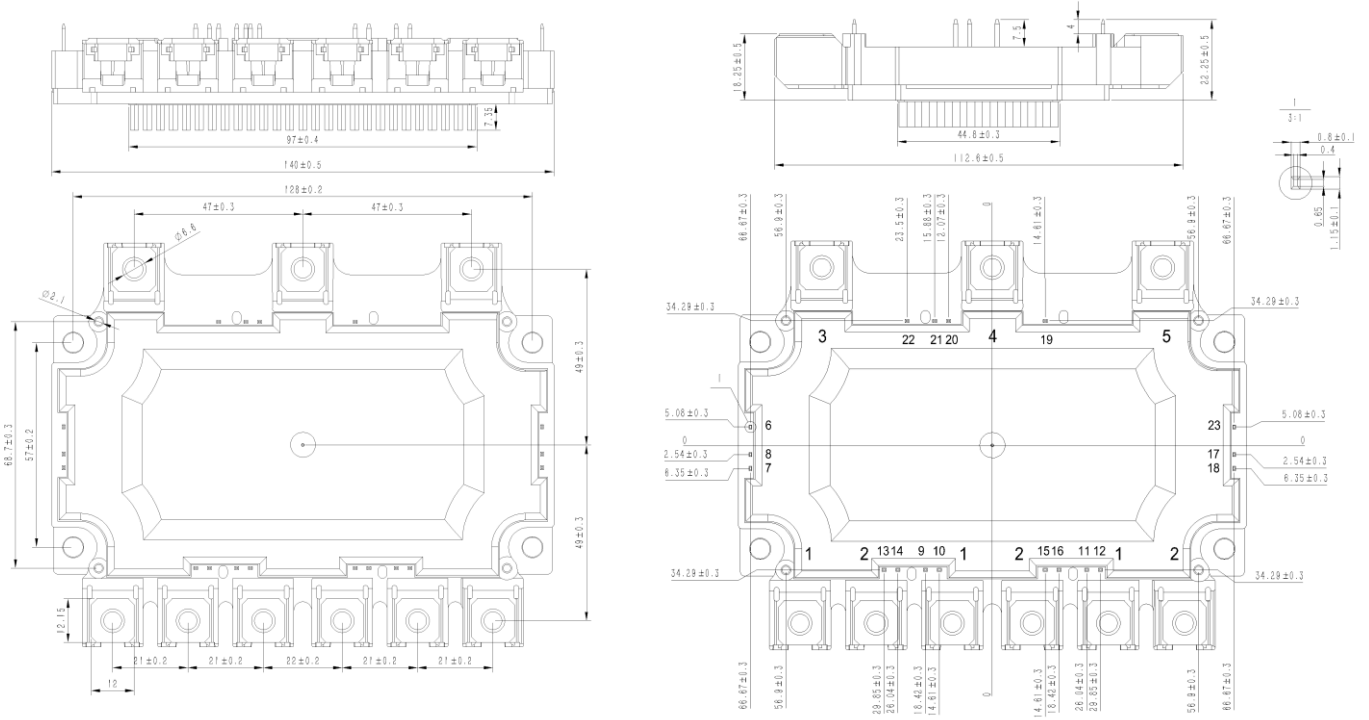

Internal Circuit / 内部电路

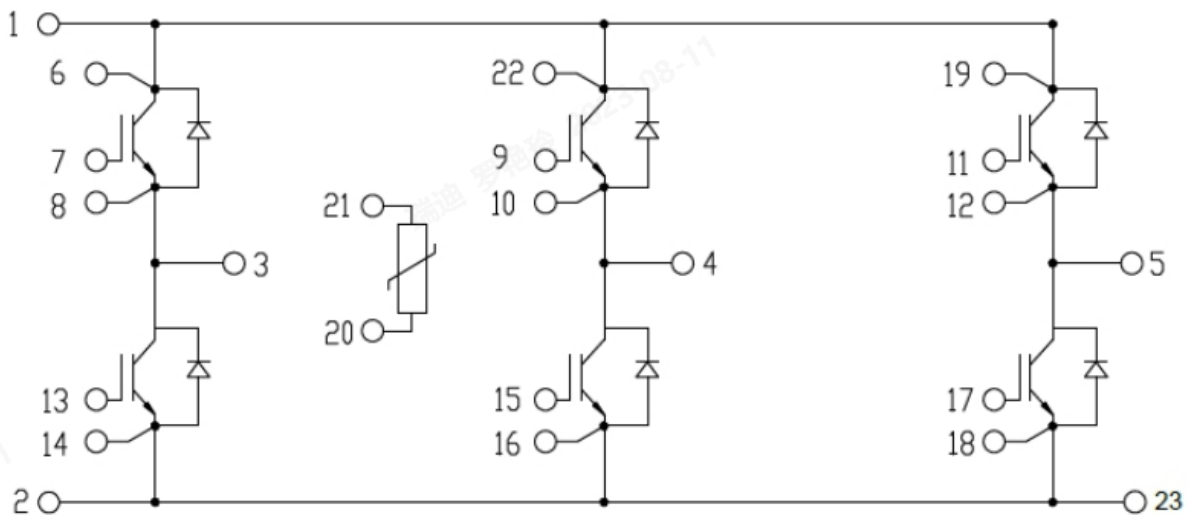

Circuit Diagram / 曲线图

Output characteristic IGBT, Inverter (typical), Inclusive R_{CC+EE}
IGBT 输出特性, 逆变 (典型值), 包含 R_{CC+EE}
 $I_c=f(V_{CE}), V_{GE}=15V$

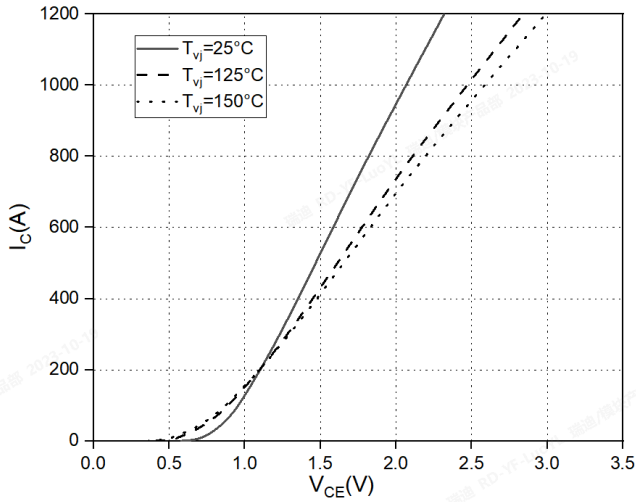

Output characteristic IGBT, Inverter (typical), Inclusive R_{CC+EE}
IGBT 输出特性, 逆变 ($T_j=150^\circ C$), 包含 R_{CC+EE}
 $I_c=f(V_{CE}), T_{vj}=150^\circ C$

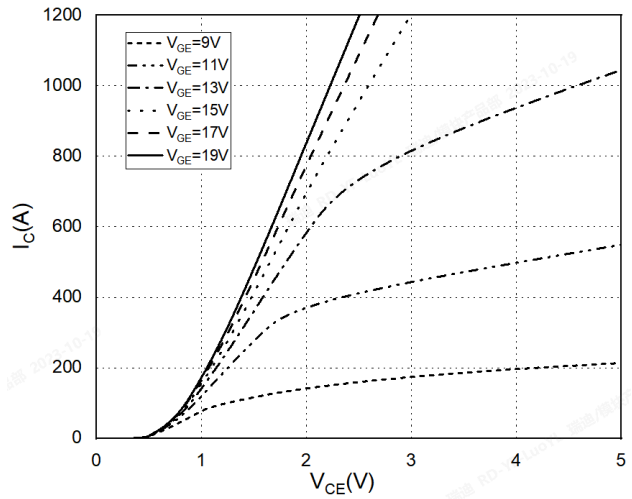

Transfer characteristic IGBT, Inverter (typical), Inclusive R_{CC+EE}
IGBT 传输特性, 逆变 (典型值), 包含 R_{CC+EE}
 $I_c=f(V_{GE}), V_{CE}=20V$

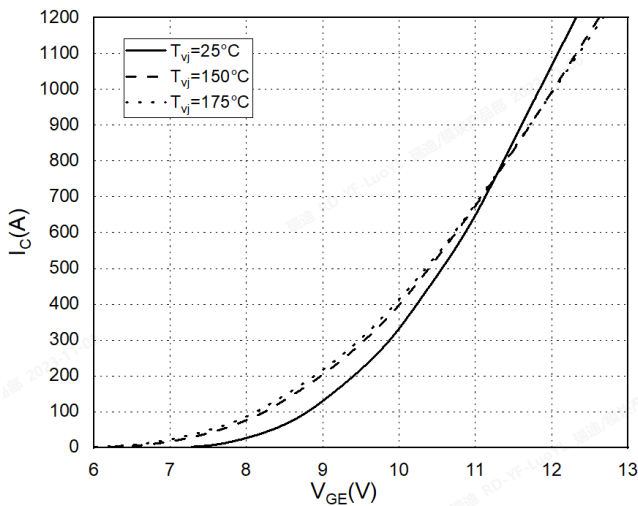

Switching losses IGBT, Inverter (typical), Inclusive R_{CC+EE}
IGBT 开关损耗, 逆变 (典型值), 包含 R_{CC+EE}
 $E=f(I_c), V_{GE}=+15V/-8V,$
 $R_{Gon}=2\Omega, R_{Goff}=12\Omega, V_{CE}=400V$

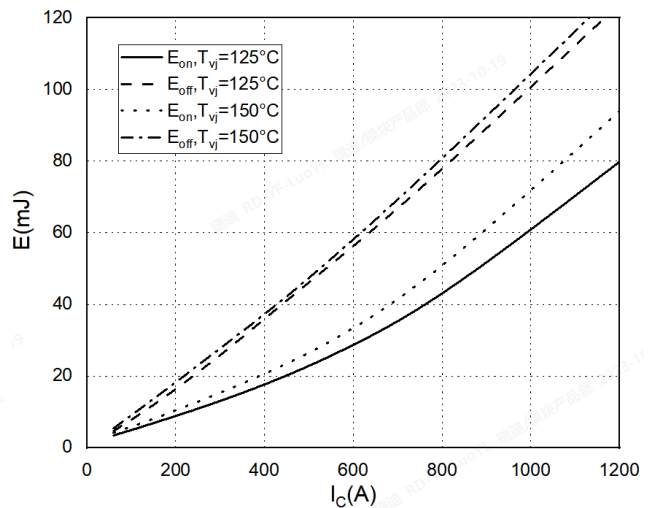

Switching losses IGBT, Inverter (typical), Inclusive $R_{CC'+EE'}$

IGBT 开关损耗, 逆变 (典型值), 包含 $R_{CC'+EE'}$
 $E_{on}=f(R_G)$, $E_{off}=f(R_G)$,
 $V_{GE}=+15V/-8V$, $I_C=600A$, $V_{CE}=400V$

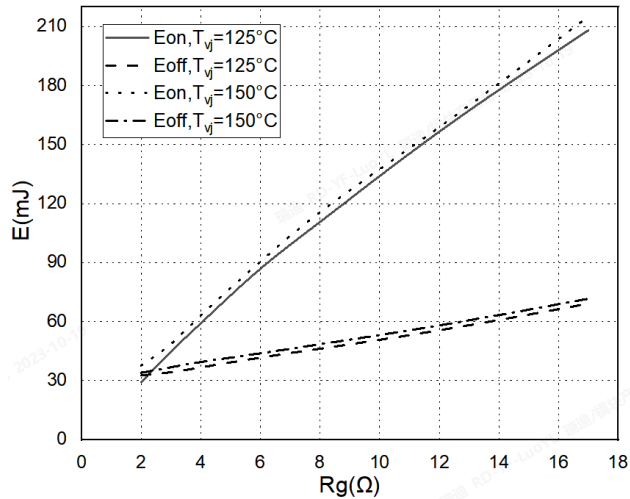

Transient thermal impedance IGBT, Inerter

IGBT 瞬态热阻, 逆变

$Z_{thJC}=f(t)$

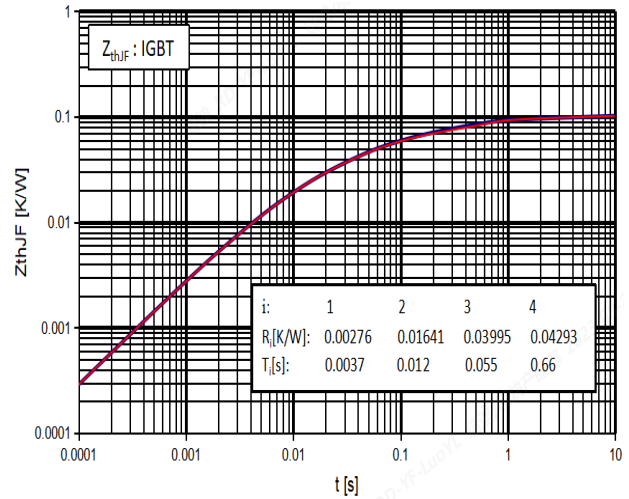

Reverse bias safe operating area IGBT, Inverter (RBSOA)

IGBT 反向安全工作区, 逆变 (RBSOA)

$I_C=f(V_{CE})$, $V_{GE}=+15V/-8V$, $R_{Goff}=12\Omega$, $T_{vj}=150^\circ C$

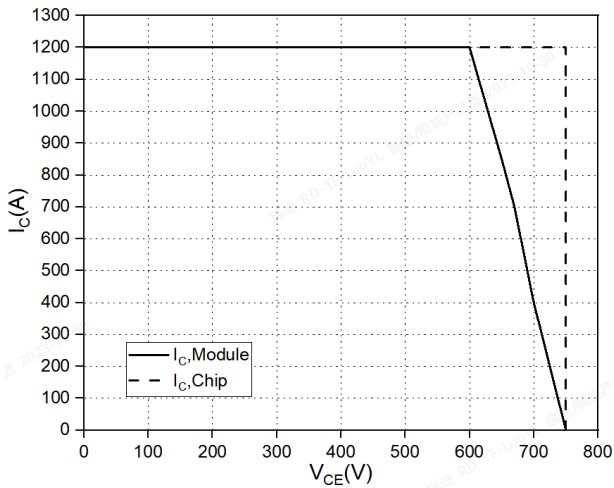

Forward characteristic FRD, Inverter (typical), Inclusive $R_{CC'+EE'}$

FRD 正向特性, 逆变 (典型值), 包含 $R_{CC'+EE'}$

$I_F=f(V_F)$

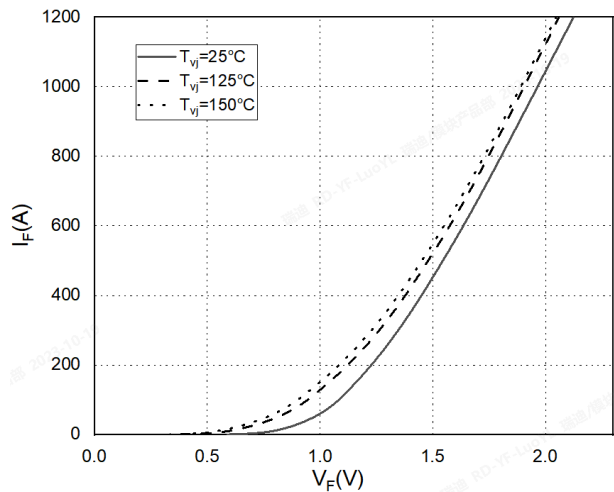

**Switching losses FRD, Inverter (typical),
Inclusive $R_{CC'+EE'}$**

FRD 开关损耗, 逆变 (典型值), 包含 $R_{CC'+EE'}$
 $E_{rec}=f(I_F), R_{Gon}=12\Omega, V_{CE}=400V$

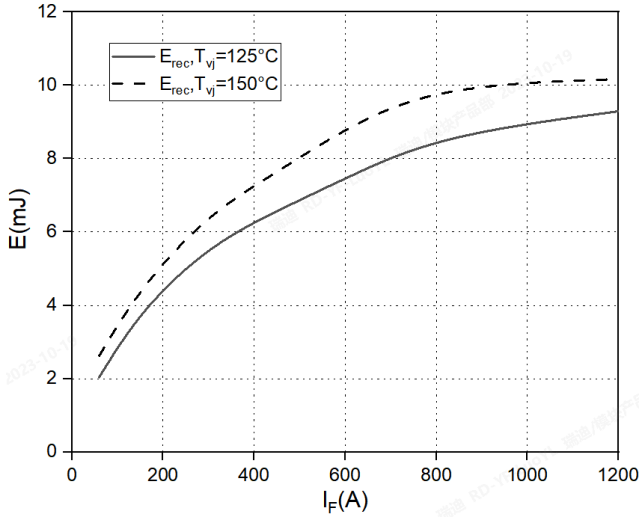

**Switching losses FRD, Inverter (typical),
Inclusive $R_{CC'+EE'}$**

FRD 开关损耗, 逆变 (典型值), 包含 $R_{CC'+EE'}$
 $E_{rec}=f(R_G), I_F=600A, V_{CE}=400V$

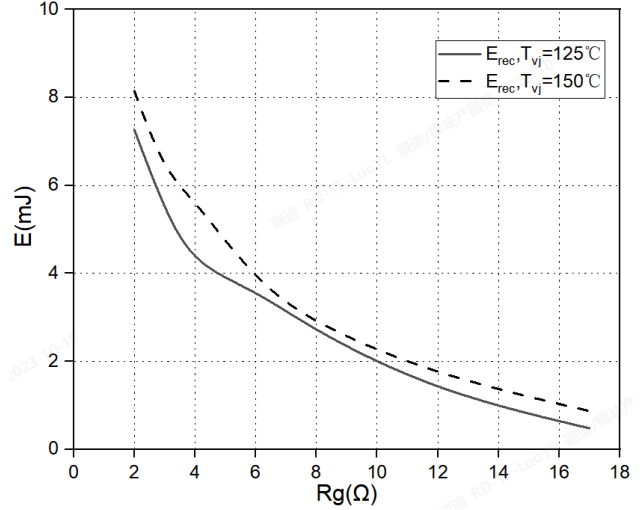

**Transient thermal impedance FRD, Inerter
FRD 瞬态热阻, 逆变**

$Z_{thJC}=f(t)$

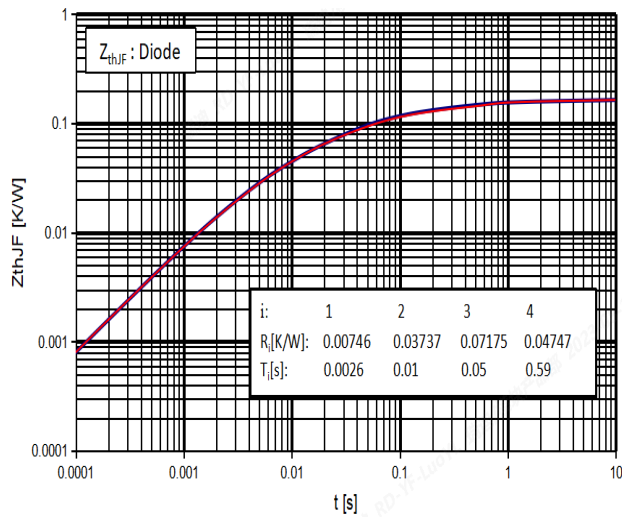

NTC Thermistor temperature characteristic (typical)

NTC 热敏电阻
 $R=f(T)$

